

Varenummer: 204080M16200A3U

Beskrivelse: E+G Justerfod
GN 40-80-M16-200-A3-U

Note: U Uden møtrik, sekskant i toppen, spændeflade i bunden

Mål

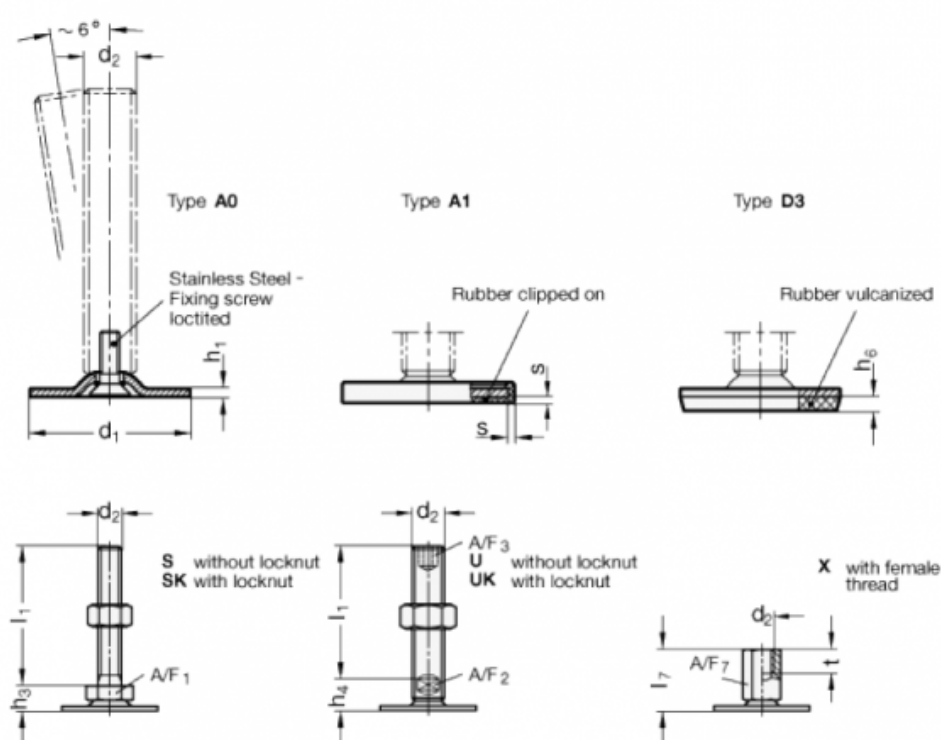

A/F2 = 12

A/F3 = 8

d1 = 80

d2 = M16

h1 = 3

h4 = 18

h6 = 5

l1 = 200

s =